

SURLAST

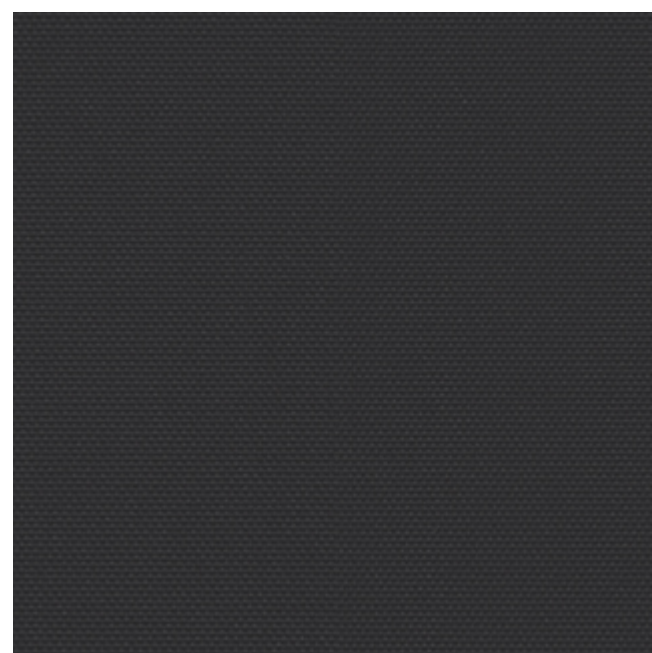

SURLAST



Black
SUR 3854 152



Admiral Navy
SUR 3866 152



Light Grey
SUR 3862 152



Sand
SUR 3853 152



WATER
RESISTANCE
Imperméabilité



COMPACT
STORAGE
Encombrement réduit



THINNESS
Finesse

● Recommended
Recommandé

● Possible

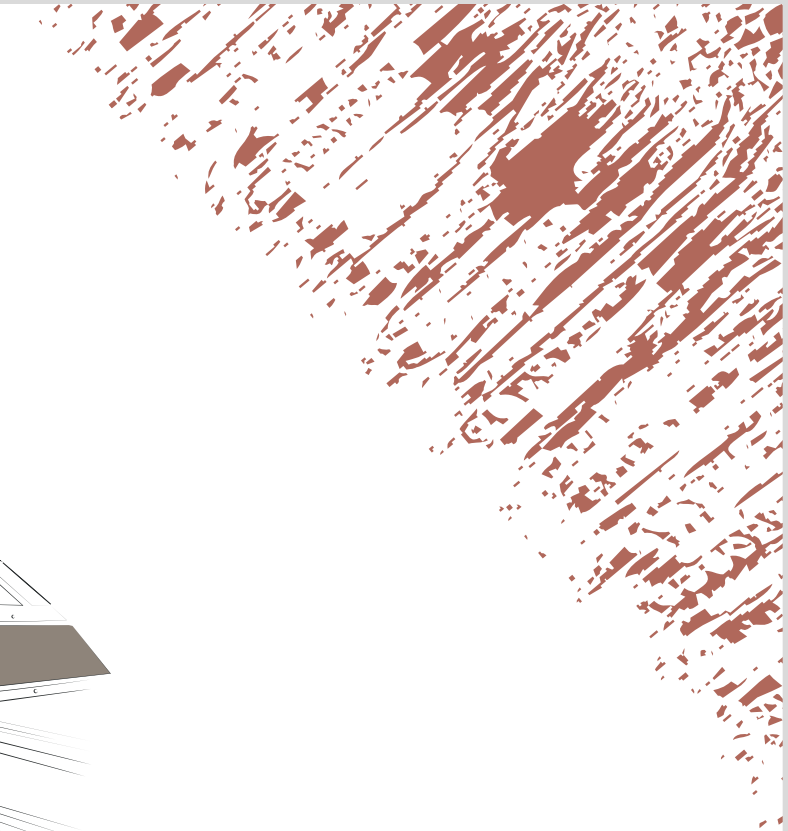
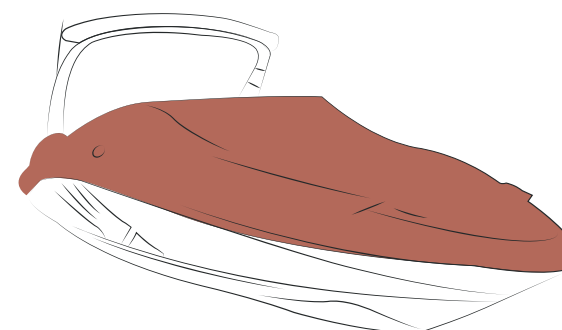
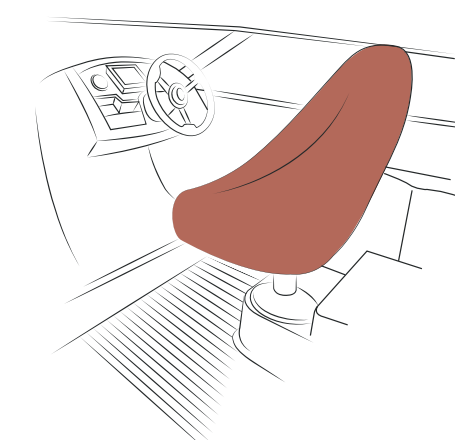
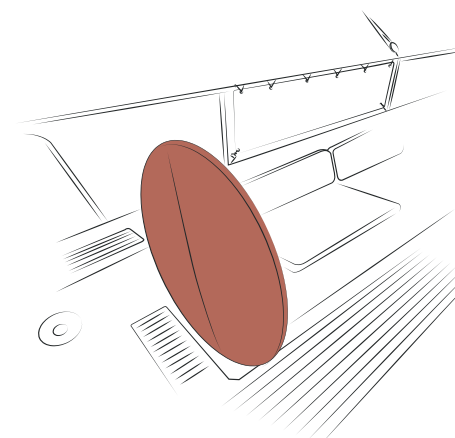
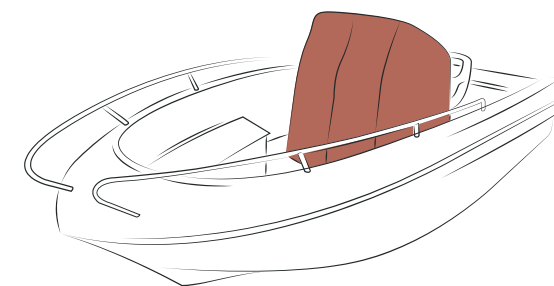
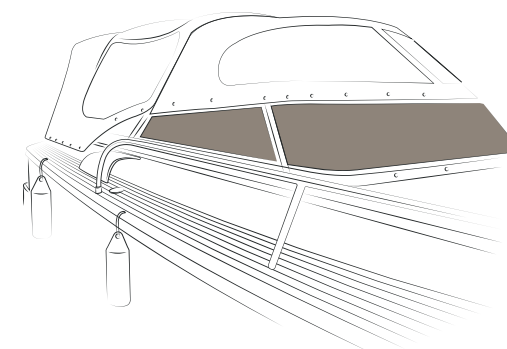



OVERALL CHARACTERISTICS / CARACTÉRISTIQUES GÉNÉRALES

Composition 100% solution dyed polyester
100% polyester teinté dans la masse

Finish / Finition PU coating on one side
Enduction polyuréthane sur une face

Weight / Poids - ISO 3801 240 g/m²

Width / Laize - EN 1773 152,5 cm

FABRIC STRENGTH / RÉSISTANCE DU TISSU

Tensile strength - ISO 13934-1 Warp 217 daN - Weft 152 daN
Résistance rupture - ISO 13934-1 Chaîne 217 daN - Trame 152 daN

Tear strength - ISO 13937-1 Warp 9,9 daN - Weft 8,7 daN
Résistance déchirure - ISO 13937-1 Chaîne 9,9 daN - Trame 8,7 daN

Schmerber - ISO 811 850 mm

COLOUR RESISTANCE / RÉSISTANCE DES COULEURS

Colour fastness weather condition 4/5
Solidité coloris intempéries - ISO 105 B04

USE / UTILISATION

Roll length / Longueur de coupe 90 m

Recommended use / Utilisation recommandée
Console cover, external windshield cover, winter cover, wheel & winch cover, fitted cover for seats
Housse de console, housse de pare-brise, housse d'hivernage, housse de barre à roue, housse de winch, housse de sièges

Guarantee / Garantie 3 years* / 3 ans**

Dickson-Constant RCS Lille Métropole 381 347 970 - Edition 06/2019
*see warranty conditions on www.dickson-constant.com - **voir conditions générales de garantie sur www.dickson-constant.com



The values of this product may vary depending on a tolerance variation of +/- 5%
Les valeurs de ce produit peuvent varier selon une tolérance de +/- 5%.